

E-ENDKAPPE

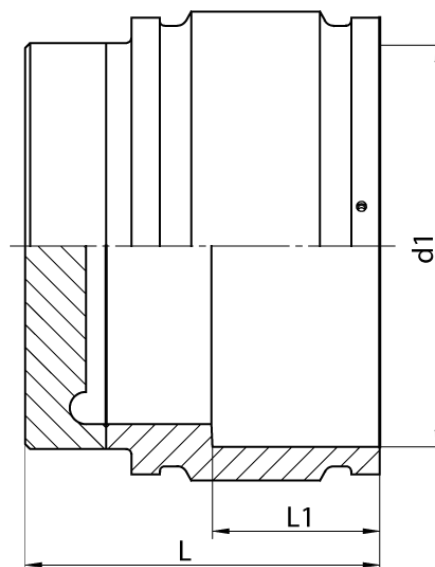

4,0 mm Steckkontakt

PE100-RC



SDR 11



Art. Nr.	d1 [mm]	D [mm]	L [mm]	L1 [mm]	kg
4334591105000000	500	621	405	175	46,09

Andere Materialien, Abmessungen und Druckstufen auf Anfrage

Lieferprogramm:

SDR17: d 250 - 1200 mm SDR11: d 250 - 1200 mm

Bei Fragen wenden Sie sich gerne an uns: Tel. + 49 281 98 414 - 0