

# E-ENDKAPPE

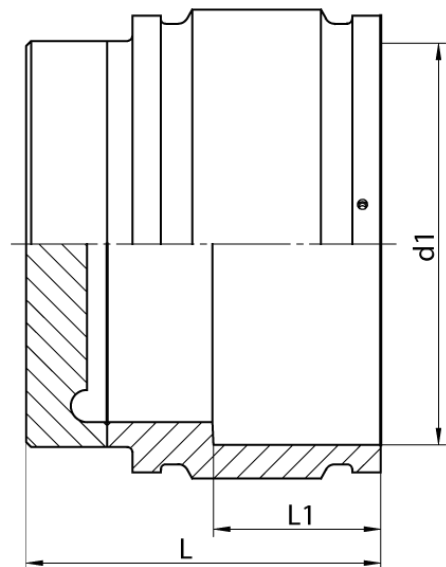

4,0 mm Steckkontakt

PE100-RC



## SDR 17



Art. Nr.	d1 [mm]	D [mm]	L [mm]	L1 [mm]	kg
4334591705600000	560	645	395	190	44,2

Andere Materialien, Abmessungen und Druckstufen auf Anfrage

Lieferprogramm:

SDR17: d 250 - 1200 mm SDR11: d 250 - 1200 mm

Bei Fragen wenden Sie sich gerne an uns: Tel. + 49 281 98 414 - 0