

E-BOGEN



$r \approx 1,5 \times d$

90°

$r \approx 1,5 \times d$
zwei separate Schweißzonen
4,0 mm Steckkontakt

PE100-RC

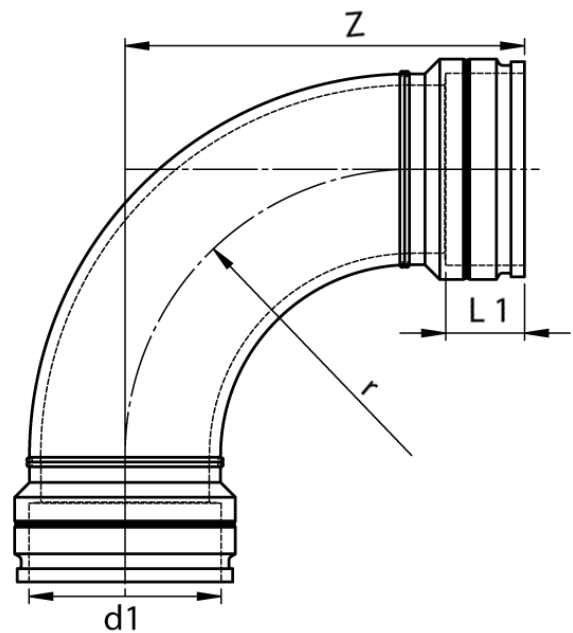

SDR 17



Art. Nr.	d1 [mm]	L1 [mm]	z1 [mm]	r [mm]	kg
4336191704000000	400	165	1020	637	55,67

Toleranz: $\alpha \pm 5^\circ$ | $z1 \pm 50$ mm
Andere Materialien, Abmessungen und Druckstufen auf Anfrage
Lieferprogramm:
SDR17: d 250 - 630 mm SDR11: d 250 - 630 mm

Bei Fragen wenden Sie sich gerne an uns: Tel. + 49 281 98 414 - 0