

langschenklig zum Stumpf- und Elektromuffenschweißen

PE100

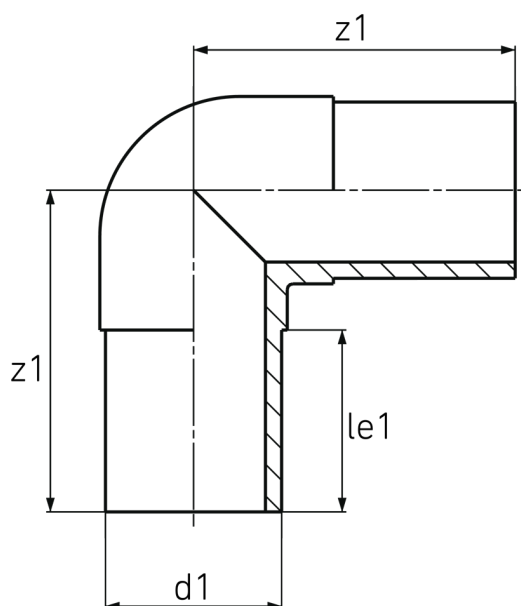

SDR 17



Art. Nr.	d1 [mm]	le1 [mm]	z1 [mm]	kg
4419021701100000	110	86	165	0,9

Toleranz: $\alpha \pm 5^\circ$

Lieferprogramm:

SDR17: d 63 - 500 mm SDR11: d 20 - 500 mm SDR7,4: d 32 - 160 mm

Bei Fragen wenden Sie sich gerne an uns: Tel. + 49 281 98 414 - 0