

kurzschenklig zum Stumpfschweißen

PE100-RC

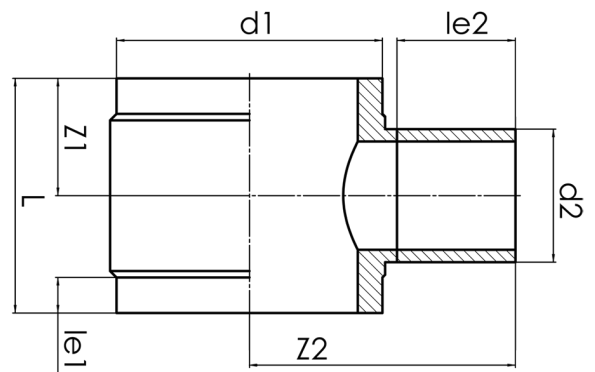

SDR 7,4



Art. Nr.	d1 [mm]	d2 [mm]	le1 [mm]	le2 [mm]	L [mm]	z1 [mm]	z2 [mm]	kg
4432200702500075	250	75	70	100	280	140	256	7,45

Andere Materialien, Abmessungen und Druckstufen auf Anfrage

Lieferprogramm:

SDR7,4: d 180 - 630 mm | SDR9: d 180 - 630 mm | SDR17: d 250 - 2250 mm |

SDR11: d 250 - 2250 mm | SDR26: d 1000 - 2250 mm

Bei Fragen wenden Sie sich gerne an uns: Tel. + 49 281 98 414 - 0