

Außengewinde

PE100

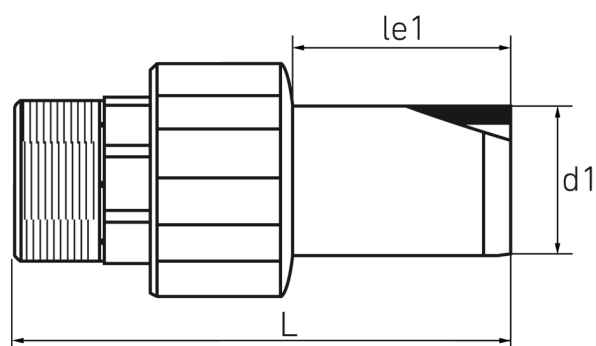

SDR 11

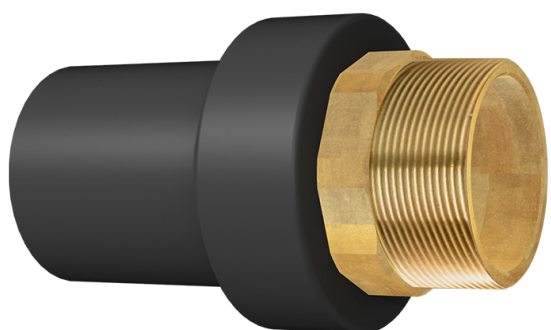

Art. Nr.	d1 [mm]	le1 [mm]	L [mm]	kg
4450401100320000	32	56	106	0,3

Lieferprogramm:
SDR11: d 20 - 125 mm

Bei Fragen wenden Sie sich gerne an uns: Tel. + 49 281 98 414 - 0